



K&M ENGINEERING SOUTION

UNIT -1

**B-54 MARUTI INDDTRIAL EASTAT
NEAR KIRAN INDUSTRIES ,PHASE-1
GIDC VATVA AHMEDABAD-382445**

UNIT-2

**Plote No.87/1/C Opp. Pushpak Estate
,G Road PHASE-1 GIDC ,VATVA
AHMEDABAD-382445**

Contct detatls: Mob. 946076960/99248579/079-25894711

**Email: k.mengineering@yahoo.com/k.mengineeringol@gmail.com
info@kmengineering.in**

Web : www.kmengineering.in

COMPANY PROFILE

Name of the Company: - K & M Engineering solution

Address of the Company: - B-54 Maruti Industrial Estate,
Near Kiran Bus stop, Bombay Conductor
Road, Phase -1 GIDC, Vatva, Ahmadabad
382445

Phone -079 25894711. Mob. 09426076960

Email: - k.mengineering@yahoo.com / k.mengineeringol@gmail.com
info@kmeengineering.in

Web :www.kmeengineering.in

GSTIN : 24AAOFK6289R1Z8

Owner of the company is graduate Engineer having vast experience of more than 28 Years in the field of engineering, Tool Room & equipment manufacturing industries. We offer a host of engineering solutions and services to our clientele. We are one of the renowned Manufacturer of **Jigs & Fixture for any Inds., Pneumatic Assembly Fixture, Inspection Fixture ,any kind of Trolleys ,FIFO racks ,Work Station , Conveyers .SPM ,Transtacker, Welding Fixture, Fabricated items , Precision Machining components for any kind of industries.**

-
1. Founded :Nov. 06, 2014
 2. Company Type :Partner ship Firm
 3. Employees :30
 4. MSME :Yes
 5. Certification :ISO 9001:2015
 6. Business Foot Print :All over India

Our 2 Unit in Ahmedabad

<https://goo.gl/maps/kfvZHisVjnF2>





Unit -1 GIDC Vatva



Unit -2 GIDC Vatva

COMPANY FACILITY

Designing Facility:

We have 3D designing Software & 3D Designing and analysis Software as Creo and Solid works. We have expert team of Design engineers to make perfect design for our client requirement

Machinery & Equipment.

1. VMC Machine AMS size 1200mm x 600mmx600mm
2. Lathe Machines 8feet,10 feet,12feet
3. Radial Drilling Machine HMT make Model RM-62 -63mm dia drilling
4. Radial Drilling Machine – Size 38mm
5. Polishing Machine
6. TIG & MIG welding machines/Electric welding machines. 18 nos
7. Pipe Bending Machine
8. we are out sourcing Hardening/Grinding/Wire cut job/laser cut jobs with our associate venders.

Instruments : Surface plate , Vernier Height gauge ,all size Simple and digital Verniers , All size micrometers , all size bore gages, Bevel protector, sleep box and other instruments.

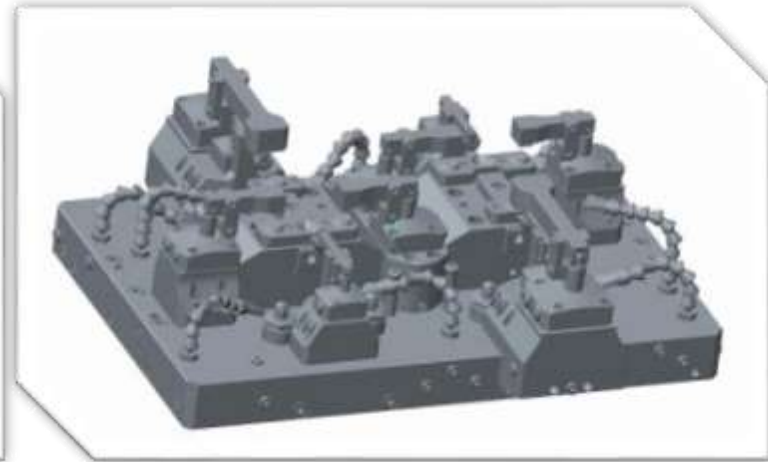
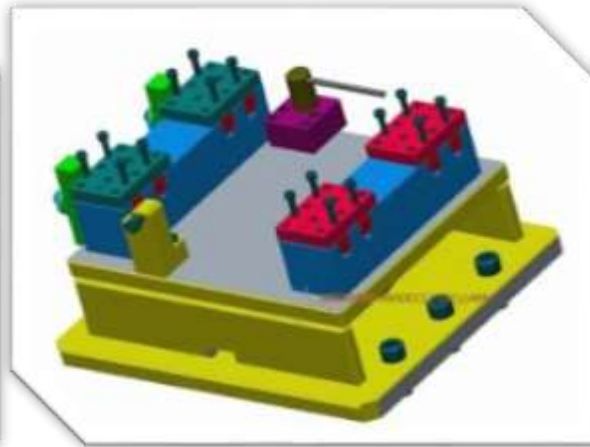
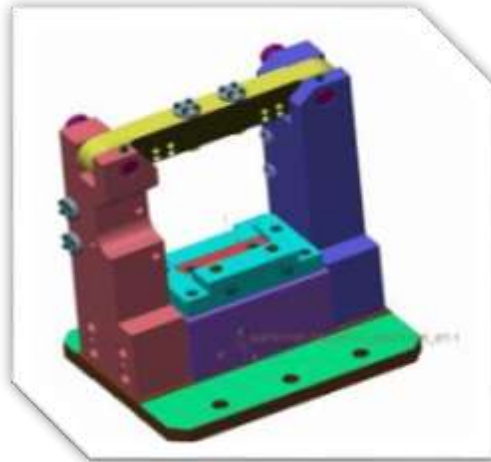

Design Creation On 3 D Designing Software

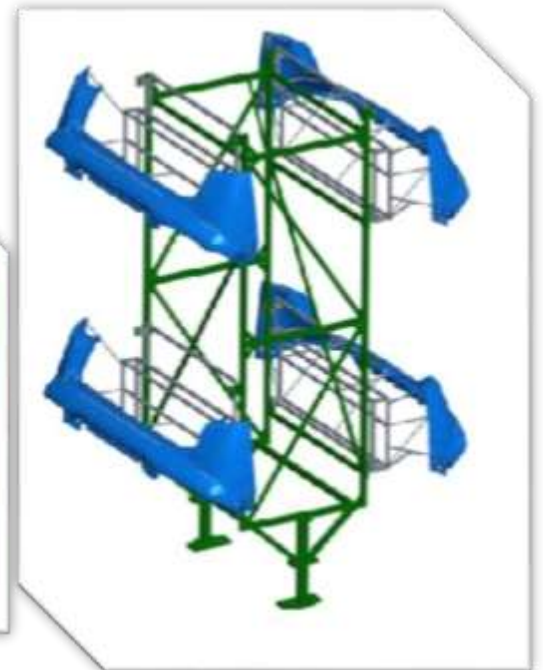



VMC Machine

Latest Manufacturing Set up



VMC Machine





POLISHING MACHINE



PILLER DRILL MACHINE



INSPECTION AREA



MIG WELDING MACHINE

Product Range

Robotic Paint shop Jigs and Inspection Fixture

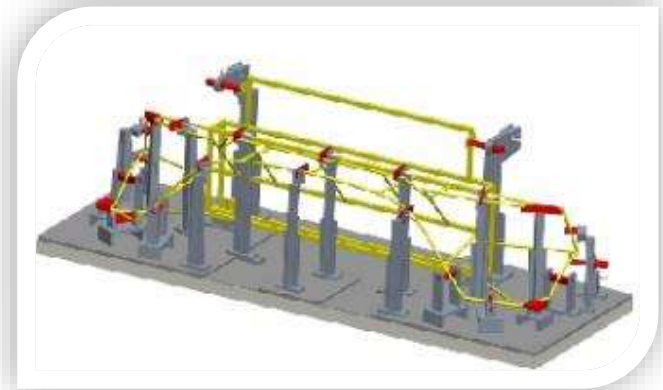
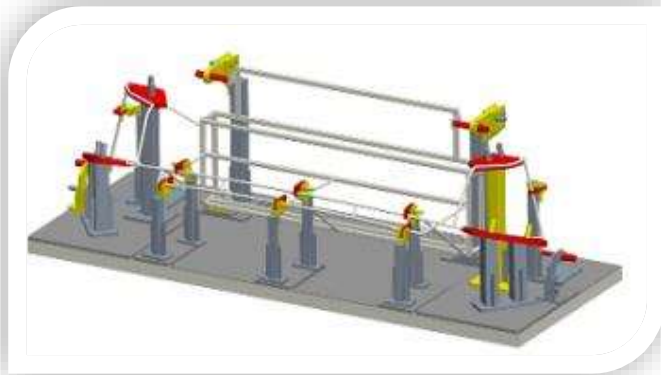
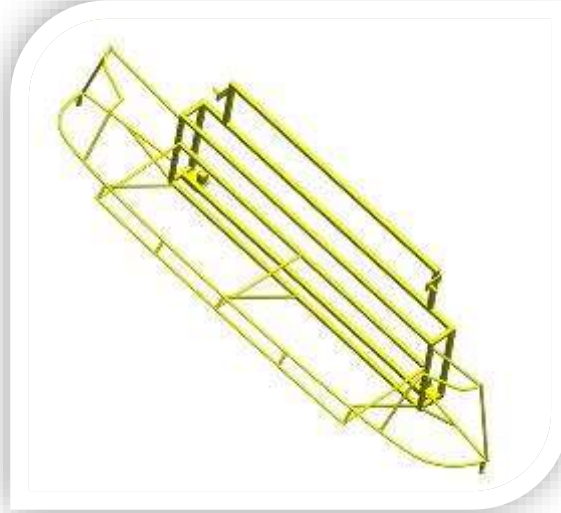
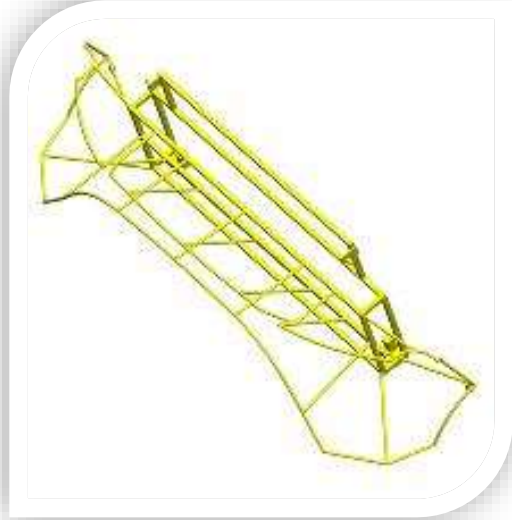

Assly Fixtures & SPM for Automotive Inds



Assly Fixtures

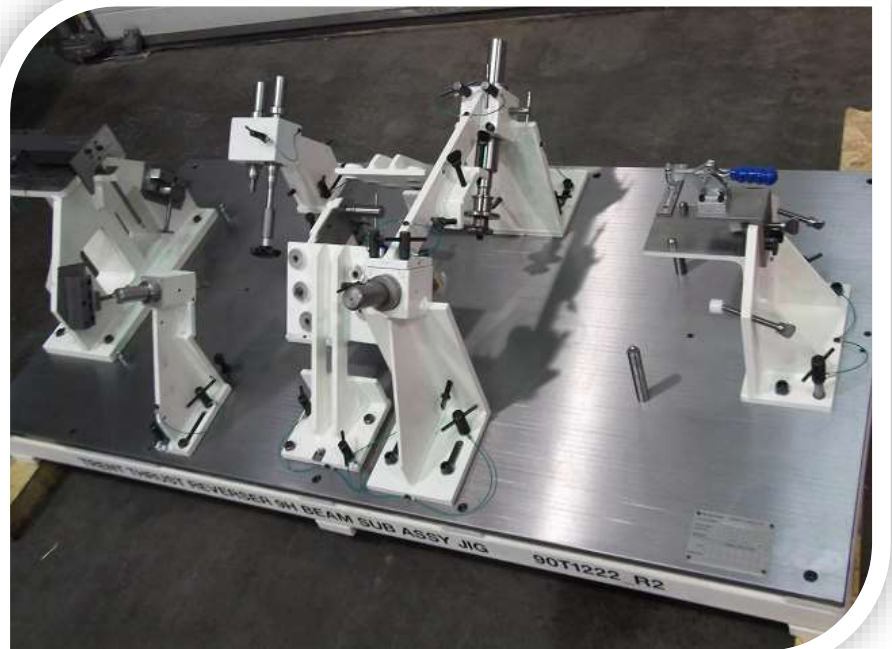

Assly Fixtures & SPM for Automotive Inds.

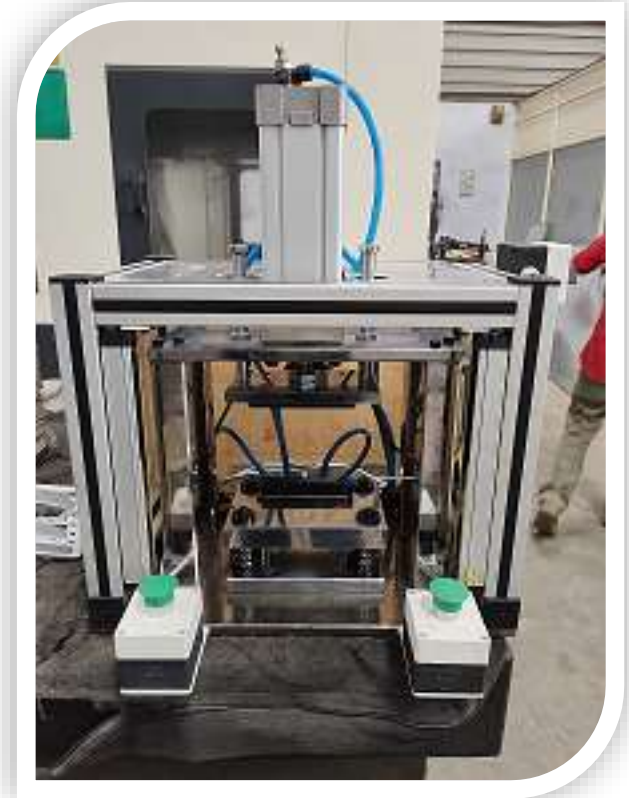

Welding fixtures .



Welding fixtures



Inspection fixtures

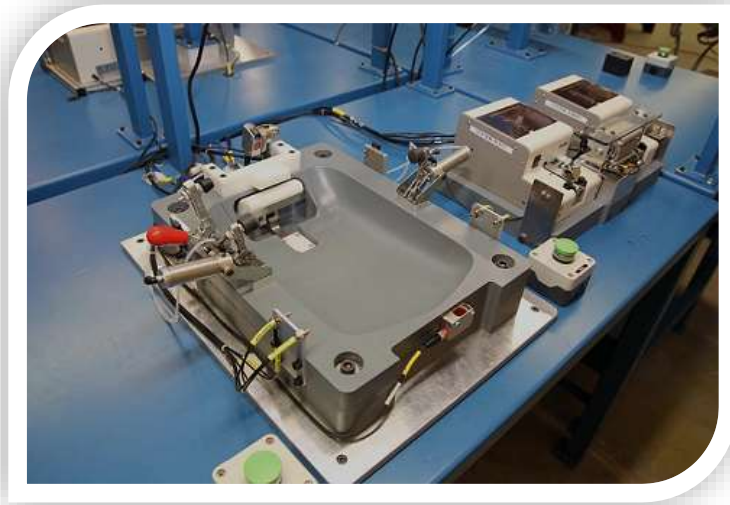

Work table bins rack for meter mfg co.



Tool Chang over Trolley



Fixture for meter mfg co

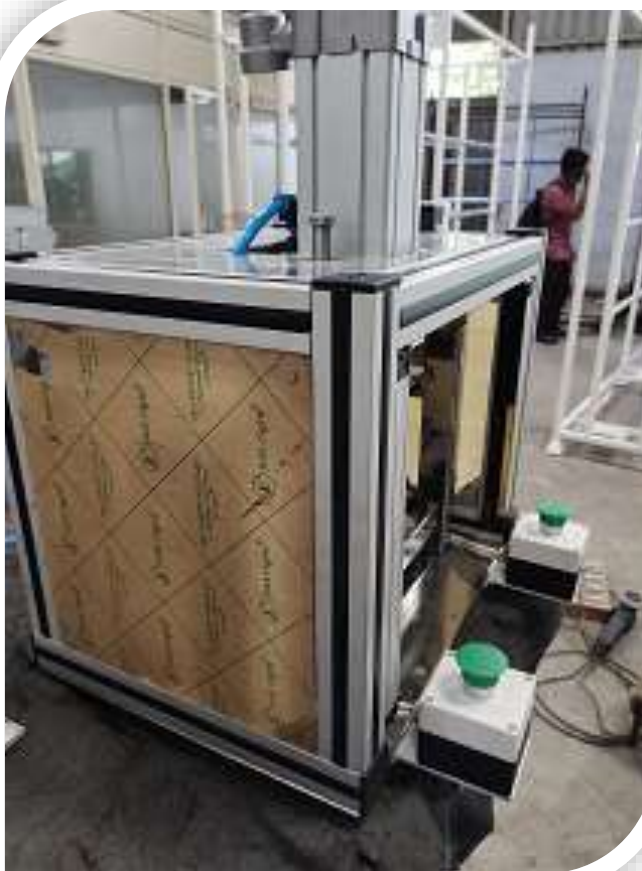



Fixture for VMC & HMC machine

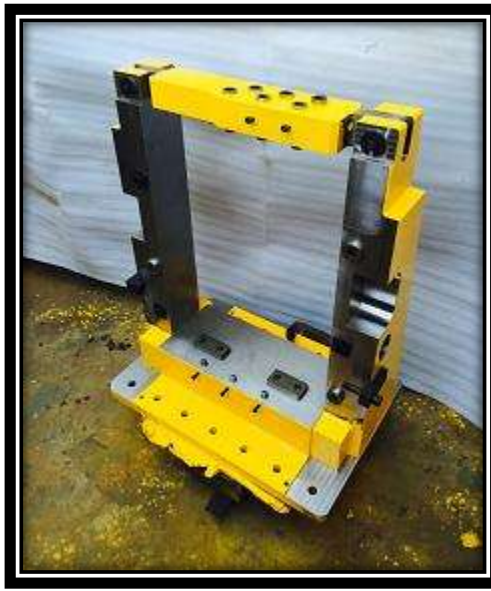

Fixture for CNC Turning



PRESS TOOLS



Press Tools



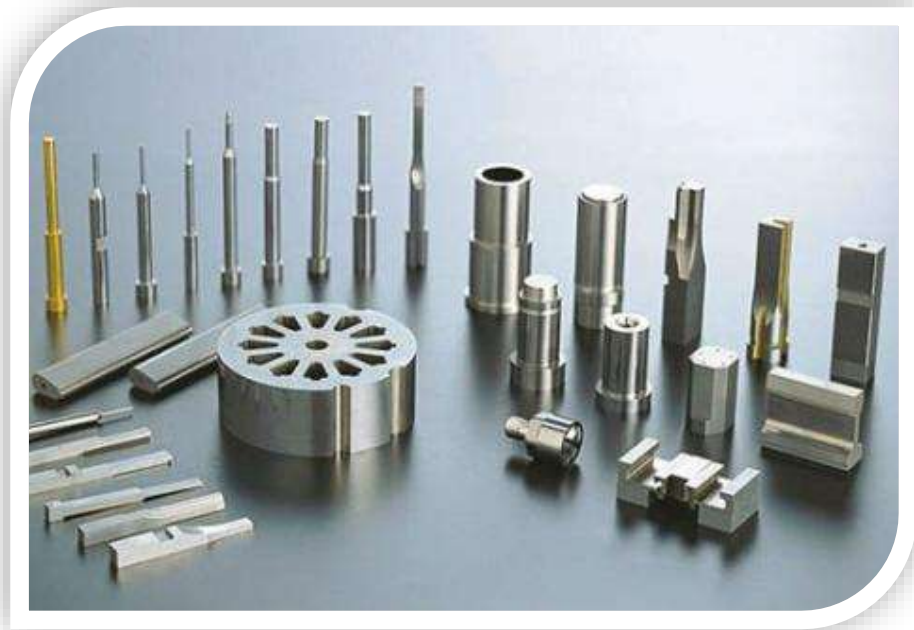

Press Tools Parts



Drilling Jigs

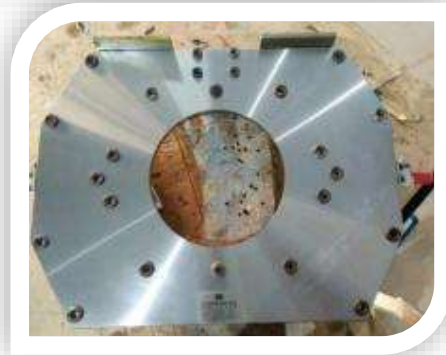
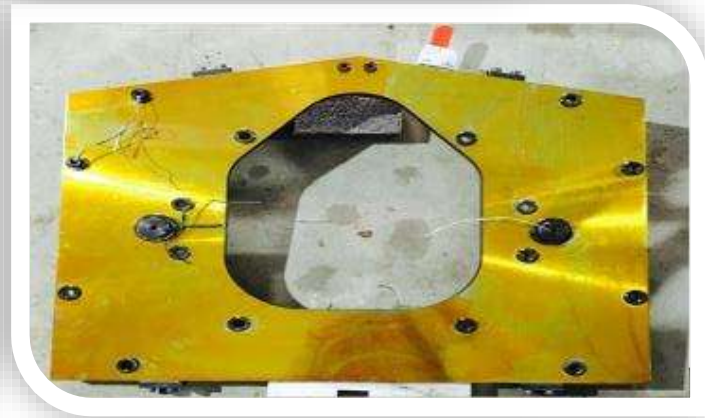

Precision Machined components Tools Parts

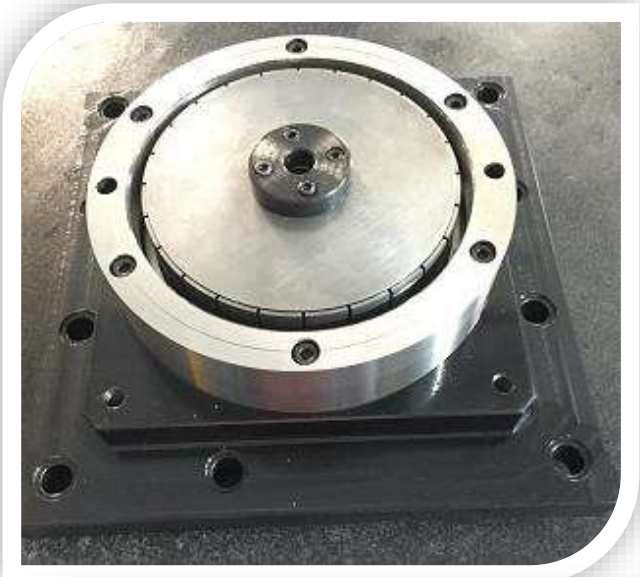

Precision Machined components & Tools Parts



WIP TROLLY & FIFO RACKS.



WIP TROLLEY & FIFO RACKS



Industrial Bins



Trolley and Work Table and Tools





FABRICATED ITEMS



5 S Training to Employee



Technical Training



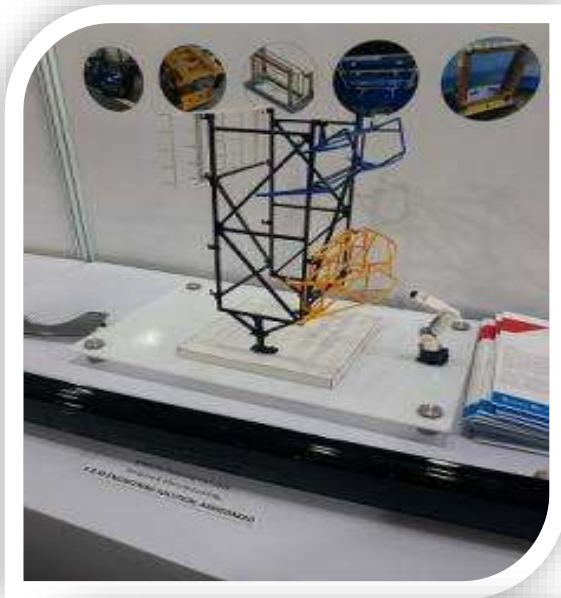

Exhibition

Our Customer List.



AMMAN APOLLO (I) PVT
Ditasan Mehsana



Ford motors (I) ltd Sanand



Our Customer List.



We believe in
YOGAM KARMASU KAUSHALAM

Thank you.